

Schottky Diodes in the New Ultra Low Profile SOD-882L Tiny Leadless Package (TLP™)

CFSH-4
CFSH2-4L

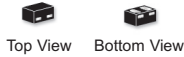

SOD-882L



TLP™ Tiny Leadless Package



features

- Halogen Free by design
- Medium Current: ($I_O=200\text{mA}$)
- Low Forward Voltage Drop:
CFSH-4 ($V_F=0.35\text{V TYP @ }1.0\text{mA}$)
CFSH2-4L ($V_F=0.53\text{V TYP @ }200\text{mA}$)
- Low Reverse Current:
CFSH-4 ($25\text{nA TYP @ }30\text{V}$)
CFSH2-4L ($350\text{nA TYP @ }40\text{V}$)
- Extremely Fast Switching: (5ns Max)
- Leadless SOD-882L TLP™ case:
1.05mm x 0.65mm with an ultra low profile of 0.4mm

Sample Devices
available
upon request.

applications

- DC/DC Converters
- Voltage Clamping
- Protection Circuits
- Battery powered applications including Cell Phones, Digital Cameras, Pagers, PDAs, Laptop Computers, etc.

description

The Central Semiconductor CFSH-4 and CFSH2-4L are high quality Schottky Diodes designed for applications where ultra small size and reasonable power dissipation are prime requirements. Packaged in the SOD-882L Tiny Leadless Package (TLP™), these devices are ideal for a wide range of power management applications.

The TLP™ Advantage

SOD-882L

Utilizes 58% Less Board Space

SOD-523

50% Lower Profile

Illustrations of devices are not shown in actual size, but are in proportion to each other. All values are shown as maximum.

selection guide



Schottky Diodes in the SOD-882L

Central Part No.	V _{RRM}	I _F	V _F		@ I _F	t _{rr}	C _T	Marking Code
	(V) MAX	(mA) MAX	(V) TYP	(V) MAX	(mA)	(ns) †TYP MAX	(pF) MAX	
CFSH-4	40	200	0.35 0.55 0.77	0.38 0.65 1.00	1.0 15 40	5.0	5.0	L
CFSH2-4L	40	200	0.33 - 0.53	0.45 0.52 0.60	10 100 200	5.0†	10	N

Schottky Diodes in the New Ultra Low Profile SOD-882L Tiny Leadless Package (TLP™)

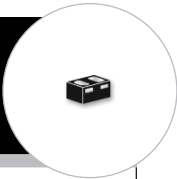

Mechanical Specifications - SOD-882L

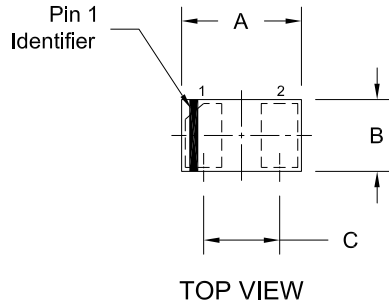

SYMBOL	INCHES		MILLIMETERS	
	MIN	MAX	MIN	MAX
A	0.037	0.041	0.95	1.05
B	0.022	0.026	0.55	0.65
C	0.026		0.65	
D	0.000	0.002	0.00	0.05
E	0.012	0.016	0.30	0.40
F	0.018	0.022	0.45	0.55
G	0.008	0.012	0.20	0.30

SOD-882L (REV:R0)

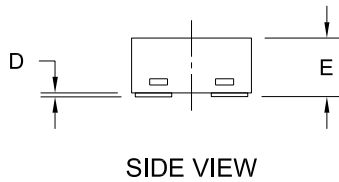

MARKING CODE:

CFSH-4 L
CFSH2-4L N

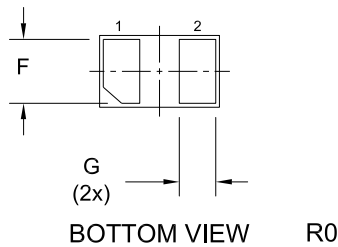

Tape Dimensions and Orientation (Dimensions in mm)

Tape Width: 8mm

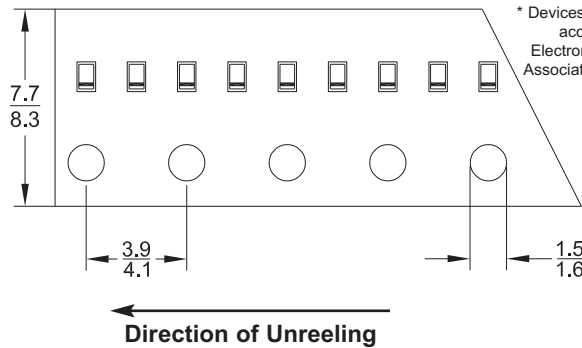

Mounting Pad Geometry (Dimensions in mm)

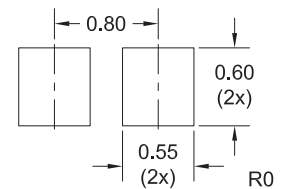

CentralTM
Semiconductor Corp.

Innovations in Discrete Semiconductors

For further information contact:
Sales at Central Semiconductor Corp.
(631) 435-1110 or visit our website at:
www.centalsemi.com

145 Adams Avenue • Hauppauge • New York • 11788 • USA • Tel:(631) 435-1110 • Fax:(631) 435-1824